

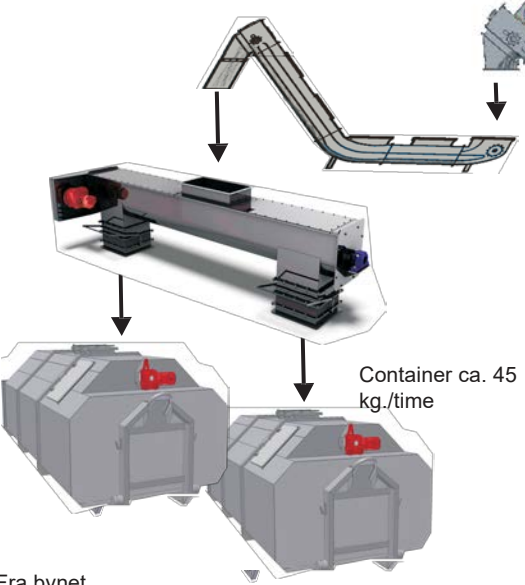

Skanderborg-Hørning FJERNVARME

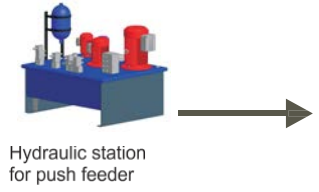

Retur Fra bynet 33 - 40 C

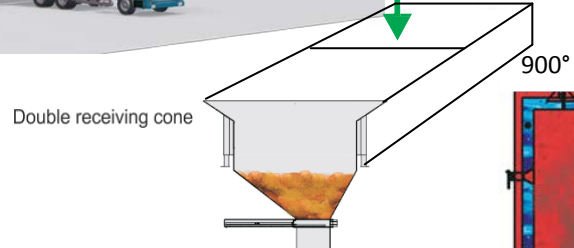
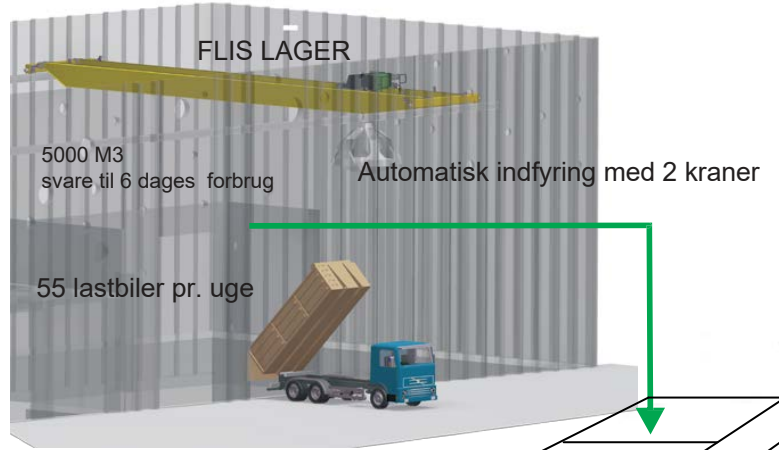
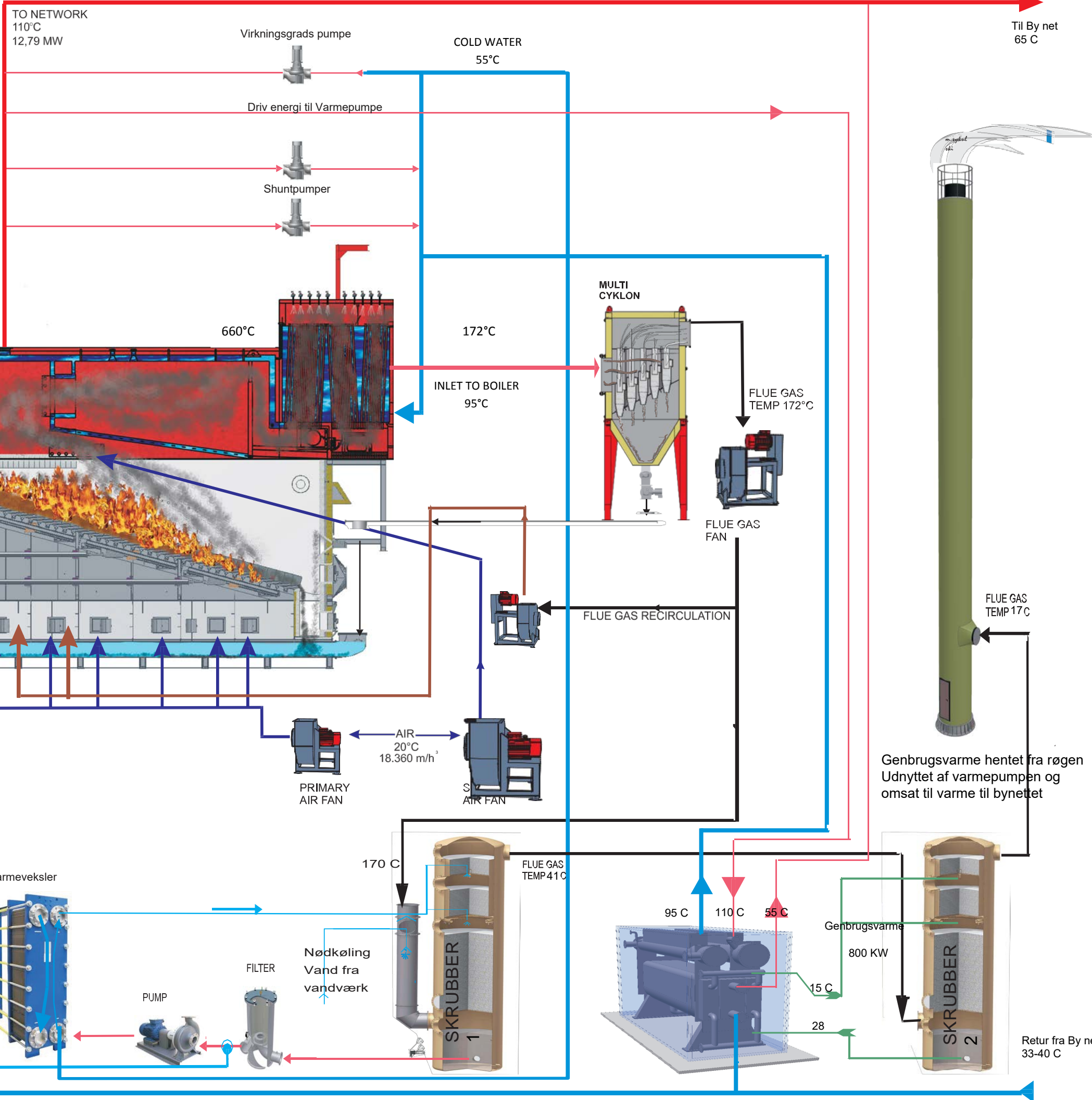
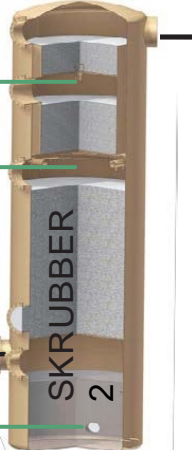
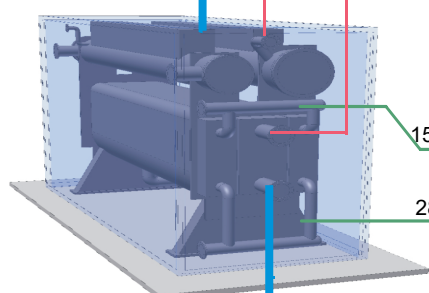
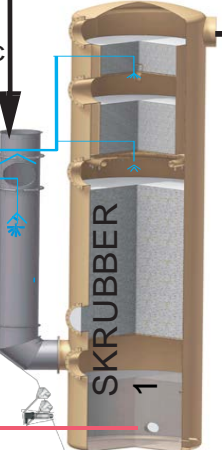
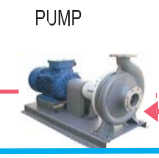
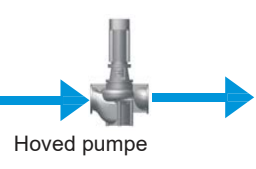
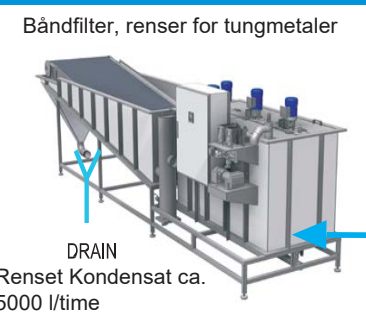

Genbrugsvarme hentet fra røgen Udnyttet af varmepumpen og omsat til varme til bynettet